



# **RB160**

## **Standard Mouthpiece Maintenance Manual**

Version 1.0  
July 2023  
Written by Tino de Rijk  
Page 1 of 31

## **Table of Contents**

|  |    |
|--|----|
| 1. Introduction .....  | 3  |
| 1.1 Functional description and limitation.....   | 3  |
| 1.2 Main operation.....  | 3  |
| 1.3 Servicing.....   | 4  |
| 1.4 Warranty.....  | 4  |
| 1.5 Copyright and Applicable Law .....   | 4  |
| 2. RB160 Standard Mouthpiece Exploded Diagrams and Parts Lists .....                     | 6  |
| 2.1 RB160 Standard Mouthpiece main assembly.....   | 6  |
| 3. General Information .....   | 7  |
| 3.1 Product overview .....   | 7  |
| 3.2 Operation.....   | 7  |
| 3.3 Initial Configuration.....   | 8  |
| 4. Service Kit Contents and Tools needed .....   | 9  |
| 4.1 RB160KIT Service Kit Contents .....  | 9  |
| 4.2 Tools Needed .....   | 9  |
| 5. Disassembly Instructions.....   | 12 |
| 5.1 General overview: main disassembly steps.....  | 12 |
| 5.2 Using the convoluted hoses from older mouthpieces .....                              | 12 |
| 5.3 Removing the mouthpiece bite from the main body.....                                 | 13 |
| 5.4 Inspect the mouthpiece bite itself for damage .....                                  | 13 |
| 5.5 Mark the position of the locking screw with a marker on the blue inhale insert ..... | 14 |
| 5.6 Unscrew the locking pin from the main body of the mouthpiece.....                    | 14 |
| 5.7 Unscrew the nickel-plated-brass operating lever .....                                | 14 |
| 5.8 Remove the blue inhale insert from the main body of the mouthpiece .....             | 15 |
| 5.9 Remove the mouthpiece inner from the main body of the mouthpiece .....               | 15 |
| 5.10 Optionally remove the one-way valves .....  | 16 |
| 5.11 Inspect all disassembled elements carefully for wear and tear.....                  | 17 |
| 6. Clean and Replace Service Parts.....  | 18 |
| 6.1 Ultrasonically clean deposits from all metal parts.....                              | 18 |
| 6.2 Replace all O-rings with new ones from the Service Kit .....                         | 18 |
| 6.3 How to lightly grease O-rings .....  | 18 |
| 7. Assembly Instructions .....   | 21 |
| 7.1 General overview: main assembly steps .....  | 21 |
| 7.2 Replace and grease all O-rings .....   | 21 |
| 7.3 Optionally fit new one-way valves to main body and blue inhale insert .....          | 21 |
| 7.4 Refit the mouthpiece inner to the main body of the mouthpiece .....                  | 22 |
| 7.5 Refit the blue inhale insert into the main body of the mouthpiece .....              | 25 |
| 7.6 Refit the nickel-plated-brass operating lever .....                                  | 26 |
| 7.7 Refit the locking pin into the main body of the mouthpiece.....                      | 26 |
| 7.8 Optionally refit the mouthpiece bite onto the main body .....                        | 27 |
| 7.9 Fit new cable tie, using cable tie tension gun .....                                 | 28 |
| 7.10 Screw the convoluted breathing hoses back onto the mouthpiece .....                 | 30 |
| 8. Testing Instructions .....  | 31 |
| 8.1 Test for leaks and proper operation.....   | 31 |

## 1. Introduction

### 1.1 Functional description and limitation

The RB160 Standard Mouthpiece is a respiratory protective device intended for diving purposes only. It must be used in conjunction with an AP Diving closed circuit rebreather, the Inspiration XPD, EVP or EVO. The whole rebreather assembly including the mouthpiece, makes it possible to supply the user with a breathable gaseous mixture under foreseeable conditions of use, whilst taking account in particular to the maximum depth of immersion with regard to the breathing gas, equipment and diver certification. Before you dive with your new mouthpiece, it is important to read the user manual in its entirety to become familiar with its features, as well as the correct procedures for setup, pre-dive inspection and post-dive maintenance.

Maximum CE-certified depth of all AP rebreathers and components is 100m.

### 1.2 Main operation



This picture shows the underside of the mouthpiece valve, showing the operating lever and the two moulded-in flanges which allow one handed operation. The rotational inner and outer body are injection moulded in a PTFE filled, self-lubricating, polymer. The operating lever is made in nickel-plated-brass and screws into a brass threaded insert, inserted during the moulding process, for added strength.

### 1.3 Servicing

Before servicing these mouthpieces, you must receive instruction and certification in the maintenance of these products by AP Diving.

Without the correct training it is possible to service and configure the RB160 Standard Mouthpiece incorrectly in an unsafe manner.

Please read the instructions in this manual carefully before servicing the product.

Factory or Dealer prescribed service for this mouthpiece is recommended annually.

The Inspiration, Evolution and Evolution+ closed circuit rebreathers' CE certification to EN14143 is unaffected by the fitting of this RB160 mouthpiece.

The RB160 Standard Mouthpiece meets the requirements of the Personal Protective Equipment Directive 89/686/EEC – CE certification when fitted to an AP Diving rebreather.



**WARNING:** When servicing the RB160 mouthpiece it is VERY important that all parts that may suffer wear and tear get replaced. It is also very important that the correct tools are used to avoid damaging any part of the product in the disassembly and assembly process. Please don't try to save money by re-using parts that really should be replaced during a proper service.

 The numbers between brackets after the part names in the disassembly and assembly chapters correspond to the sequence numbers in the diagrams in chapter 2.

### 1.4 Warranty

The RB160 Standard Mouthpiece is covered by an AP Diving 1-year warranty against defects in materials or workmanship. This warranty is only offered to the original purchaser and is not transferable. A copy of the receipt must be presented whenever obtaining warranty service.

### 1.5 Copyright and Applicable Law

#### Copyright Notice

This maintenance manual is copyrighted, all rights reserved. It may not, in whole or part be copied, photocopied, reproduced, translated to any electronic medium or machine-readable form without prior consent from Ambient Pressure Diving Ltd.

©2008 - 2023 Ambient Pressure Diving Ltd. Standard Mouthpiece Maintenance Manual

#### Applicable Law:

All products are sold on the strict understanding that only English Law applies in cases of warranty claims and product liability, regardless of where the equipment is purchased or used. Should a claim be made then the venue for this would be in Truro, England. If this clause is not acceptable to you or your family then return the product unused to your place of purchase for a refund.

**Manufacturer:**

Manufactured in the UK by Ambient Pressure Diving Ltd, Unit 2C, Water-Ma-Trout Industrial Estate, Helston, Cornwall, TR13 0LW, Telephone +44(0)1326 563834.

**EC Type Approval & Conformity Assessment:**

EC Type certification, module B & D of PPE regulation (EU) 2016/425, by SGS FIMKO OY, Takomotie 8, FI-00380 Helsinki, Finland.  
Notified Body Number 0598.

**UK Type Approval & Conformity Assessment:**

UKCA certification. Module B & D of PPE Regulation EU 2016/425 as amended and adopted in UK law, by SGS UK Approval Body 0120; SGS UK Ltd, Rossmore Business Park, Ellesmere Port, Cheshire CH65 3EN.

**EC & UK Declaration of Conformity:**

The latest manufacturers Declaration of Conformity can be found on the Ambient Pressure Diving website: <https://www.apdiving.com/en/rebreathers/resources/useful-info/>

**General Precautions and Warnings**

Before using this mouthpiece, you must receive instruction and certification in diving rebreathers from a recognised training agency. Use of this mouthpiece by uncertified or untrained persons is dangerous and can result in injury or death. It is very easy to configure the mouthpiece and/or use it in an unsafe manner. Even if specific training is undertaken in its configuration and use, it is still possible to injure yourself through carelessness.

## 2. RB160 Standard Mouthpiece Exploded Diagrams and Parts Lists

### 2.1 RB160 Standard Mouthpiece main assembly

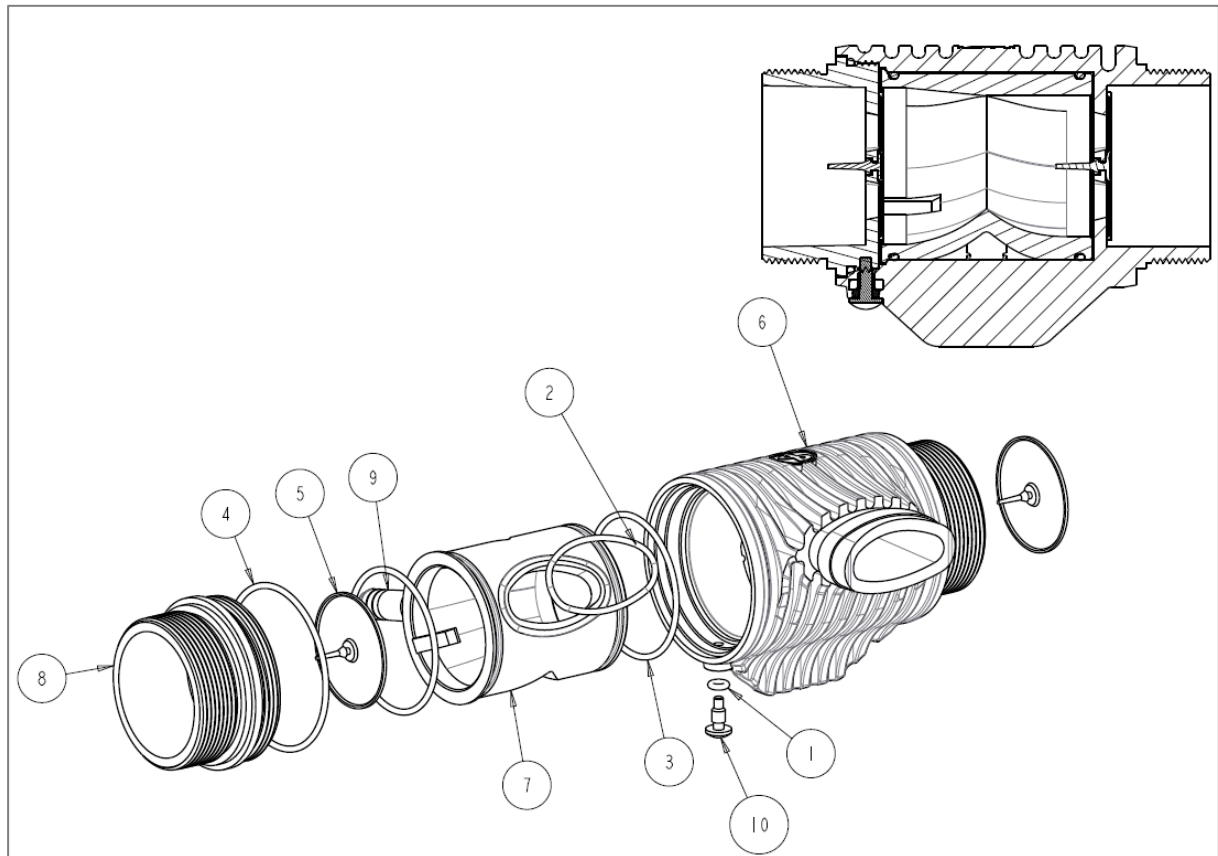

| <b>NUMBER</b> | <b>DESCRIPTION</b>                          | <b>PART NUMBER</b> | <b>QUANTITY</b> |
|---------------|---|--------------------|-----------------|
| 1             | BS006 N70 O-ring                            | BS_006_N70         | 1               |
| 2             | BS024 EPDM70 O-ring                         | BS_024_EPDM70      | 1               |
| 3             | BS029 EPDM70 O-ring                         | BS_029_EPDM70      | 2               |
| 4             | BS032 N70 O-ring                            | BS_032_N70         | 1               |
| 5             | One-way valves                              | RB_02_05           | 2               |
| 6             | Standard mouthpiece<br>outer                | RB_160_1           | 1               |
| 7             | Standard mouthpiece<br>inner                | RB_160_2           | 1               |
| 8             | Standard mouthpiece<br>inhale insert (blue) | RB_160_3           | 1               |
| 9             | Standard mouthpiece<br>lever                | RB_160_4           | 1               |
| 10            | Standard mouthpiece<br>locking pin          | SC_310             | 1               |

### 3. General Information

#### 3.1 Product overview

The mouthpiece, as delivered by the factory, is fitted with the RBSM Safety Mouthpiece bite, as pictured below.

However, if needed (but not recommended), the RBSM Safety Mouthpiece bite can be swapped out for an AP100D mouthpiece bite (shown in 7.8).



#### 3.2 Operation

As described in the user manual, the operation of the RB160 while in use is as follows:

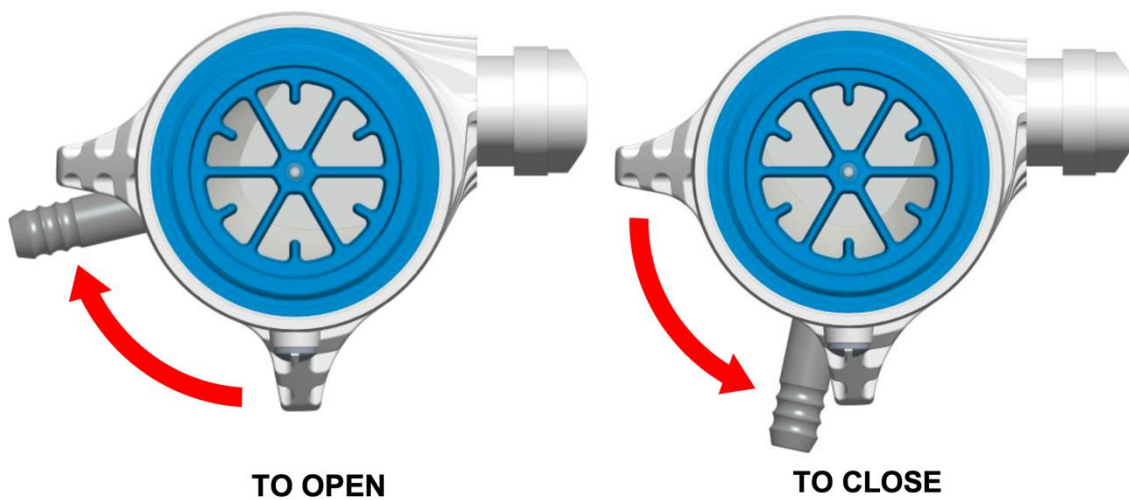

These two modes (Open and Closed) are selected by moving the lever forwards or backwards, which in turn rotates the internal components within the main body:

- The open “rebreather” mode is activated by rotating the lever up, away from your chin, where the lever is opposite the mouthpiece opening.
- The closed position is activated when the lever is pulled down, towards your chin, where the lever is perpendicular to the mouthpiece.

### 3.3 Initial Configuration

The RB160 Standard Mouthpiece is retrofittable to all AP Diving Rebreathers.

1. To replace an existing mouthpiece, simply remove the two stainless steel pozidrive screws which hold your convoluted inhale (RB07/03) and exhale hoses (RB07/04) to your existing mouthpiece or OCB.
2. Unscrew both hoses from your current mouthpiece or OCB.
3. Now screw your convoluted hoses onto your new RB160 Standard Mouthpiece, taking care not to cross thread the components and ensuring the blue insert end of the mouthpiece is connected to your inhale hose (RB07/03), which is the hose fitted with the blue ident rings.  
Tighten securely, but hand-tight is sufficient.
4. Do **NOT** refit the steel pozidrive screws; they are no longer required as the rotational inner is separated from the male-threaded hose connections, which eliminates rotational force on the hose connection while in operation.

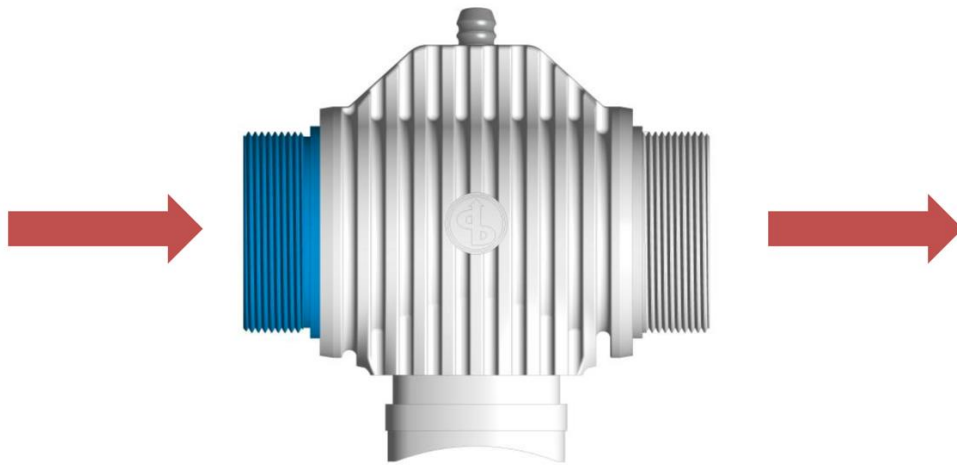

Gas flow direction through the mouthpiece is the same as in all AP rebreathers:  
from left to right of the user.



## 4. Service Kit Contents and Tools needed

### 4.1 RB160KIT Service Kit Contents

The service kit RB160KIT for the RB160 Standard Mouthpiece contains the following items:

| <b>RB160KIT</b> | <b>DESCRIPTION</b>                        | <b>QUANTITY</b> |
|-----------------|---|-----------------|
| 1               | BS006 N70 locking pin O-ring              | 1               |
| 2               | BS024 EPDM70 mouth opening O-ring         | 1               |
| 3               | BS029 EPDM70 mouthpiece inner O-rings     | 2               |
| 4               | BS032 N70 mouthpiece inhale insert O-ring | 1               |
| 5               | RB_02_05 One-way valves                   | 1 pair          |

**⚠ WARNING:** When replacing O-rings, the size, the material and the hardness of the O-rings (declared in degrees shore, and indicated by the suffixes N70 in the parts lists in chapter 2) is **ESSENTIAL** for proper operation. If, against our recommendation, you choose to select your O-rings to come from another source than AP Diving, make sure you select the right size, hardness, **AND** material (composition).



### 4.2 Tools Needed

#### Special tool

There is one special tool needed for servicing the RB160 Standard Mouthpiece. This tool is needed to unscrew the blue inhale insert (RB\_160\_3) without damaging either the external thread or the delicate internal spider-frame that holds the silicone one-way inhale valve.

The part number is RBTOOL22, pictured below:



### Normal tools

Normal tools needed are:

- A 4mm Allen key or torque wrench with low torque settings down to 2 Newton Meter
- A screw driver, preferable with torque setting capability down to 2 Newton Meter
- O-ring picking tools
- Silicone grease
- (Access to) an ultrasonic bath for cleaning
- A cable tie tension gun.

A proper cable tie tension gun can be found amongst others at

<https://www.rapidonline.com/anvil-av-cttg-cable-tie-tension-gun-86-0522> .

This tool is needed for the proper tensioning and cutting of the cable tie that seals the mouthpiece bite onto the main body.



A more expensive tension gun with more adjustment capabilities can be found here:

<http://uk.farnell.com/hellermann-tyton/mk9-9a/installation-tool-t80-ties/dp/1296251>



Whichever tool is used, the cable tie tension has to be tested and pre-set to the correct value before attaching a mouthpiece bite.

**!** **WARNING:** Do **NOT** use aggressive chemicals. They might damage the surface plating of the metal parts of the RB160 Standard Mouthpiece. Use an ultrasonic cleaning bath with a suitable cleaning fluid. A very good cleaning fluid is Biox "O2" immersion fluid, but the exposure time to this fluid must be **LIMITED** to 10 minutes.

See [WWW.BIOXINT.COM](http://WWW.BIOXINT.COM) for further information and distributors.

## 5. Disassembly Instructions

### 5.1 General overview: main disassembly steps

There are 11 steps in the disassembly process:

1. Remove the convoluted breathing hoses from the mouthpiece
2. Removing the mouthpiece bite from the main body
3. Inspect the mouthpiece bite itself for damage
4. Mark the position of the locking screw with a marker on the blue inhale moulding
5. Unscrew the locking pin from the main body
6. Unscrew the metal operating lever
7. Remove the blue inhale insert from the main body
8. Remove the mouthpiece inner from the main body
9. Optionally remove the one-way valves
10. Remove all O-rings; replace them with new ones
11. Inspect all disassembled elements carefully for wear and tear

### 5.2 Using the convoluted hoses from older mouthpieces

- This is **ONLY** necessary when replacing a previous model APD mouthpiece by the new RB160 Standard Mouthpiece.
- The previous APD mouthpieces were locked in place using small stainless steel pozidrive locking screws. Simply unscrew them and discard.
  - The locking screws are not required on the new RB160 Standard Mouthpiece because opening and closing the mouthpiece, using the new lever, does not cause any rotational moment to the hoses or locking rings.

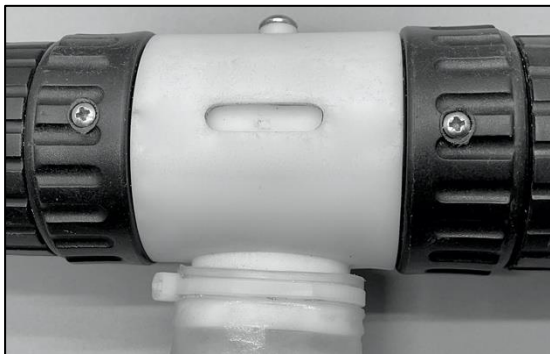

- Unscrew and remove the convoluted breathing hoses from the old mouthpiece. Check the sealing O rings in the hose end fittings are clean and lubricated with silicon grease and screw them onto the new mouthpiece.
- Ensure that the inhale hose which usually has **BLUE** markings is attached to the **BLUE** moulding on the left side.

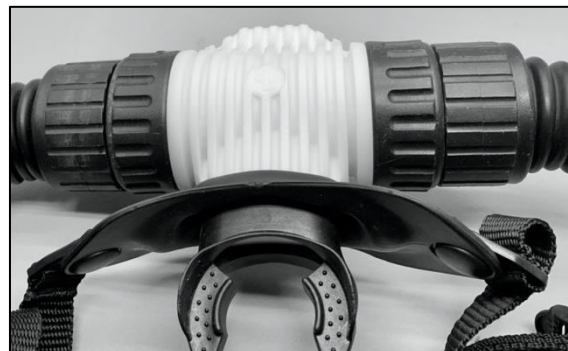

### 5.3 Removing the mouthpiece bite from the main body

**NOTE:** It is not necessary to replace the mouthpiece bite at each service interval, but it **IS** necessary to carefully inspect it for wear & tear and correct fitting.

- If the mouthpiece bite is not correctly located or if there is any sign of damage or deterioration, the mouthpiece bite should be removed and replaced.

Removing the cable tie allows for proper inspection but must only be removed if you have sufficient ability, tools and replacement parts to properly re-secure the new mouthpiece bite. Inspect for proper positioning of the mouthpiece bite on the main body, as indicated in paragraph 7.8.

- When replacing the cable tie, make sure to use an original one from AP Diving. The original ones are guaranteed to be able to handle the significant amount of tension that needs to be applied to ensure a firm fixation of the mouthpiece bite onto the main body.
- If the cable tie is not tightened sufficiently, there is a risk of the mouthpiece bite coming adrift from the main housing during the dive; likewise, if an inferior quality cable tie is used.

When removing the old cable tie from the mouthpiece bite take extra care not to damage the mouthpiece bite in the process.

- The best way to remove the cable tie is to cut the closure in a **VERTICAL** way, as shown in the pictures below.

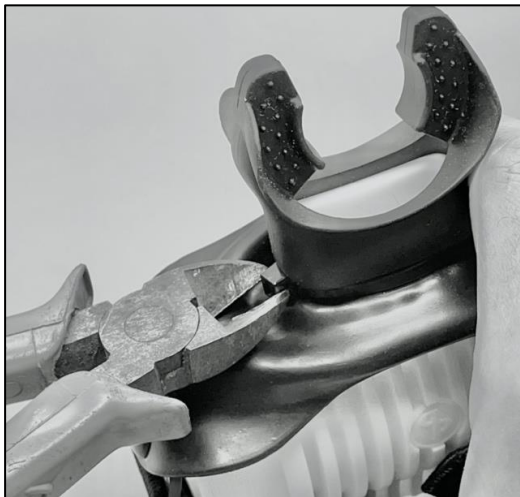

### 5.4 Inspect the mouthpiece bite itself for damage

Inspect the mouthpiece bite itself carefully for any damage along the outside seam or on the bite lugs of the mouthpiece bite. See arrows below for areas to be inspected.

- If any damage is found, replace the mouthpiece bite.

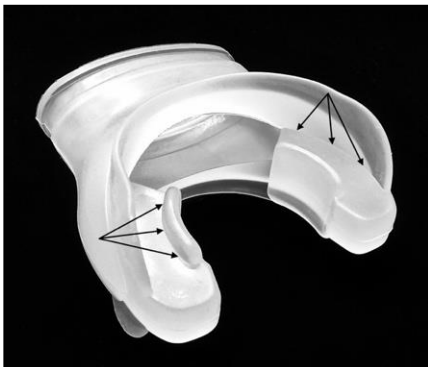



### 5.5 Mark the position of the locking screw with a marker on the blue inhale insert

Using a permanent black marker, make a mark on the blue inhale insert opposite the position of the locking screw. This is important in order to correctly reposition the blue inhale insert later during assembly, in exactly the right position.

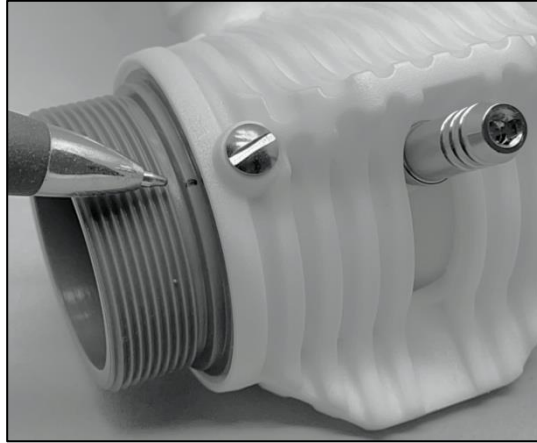

### 5.6 Unscrew the locking pin from the main body of the mouthpiece

Make sure you also remove the O-ring. Screw counter-clockwise.



### 5.7 Unscrew the nickel-plated-brass operating lever

Close the mouthpiece before using a 4mm Allen key and rotating counter-clockwise.

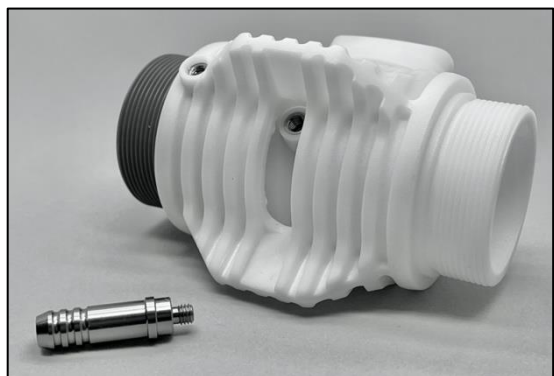

## 5.8 Remove the blue inhale insert from the main body of the mouthpiece

Use special tool RBTOOL22 to remove the blue insert from the main body.

**WARNING:** if you don't use the special tool there is a risk of dangerously damaging the sealing face of the non-return valve.

Insert the special tool in such a way that it locks properly onto the spider plate that holds the one-way valve. Apply sufficient pressure on the special tool while rotating counter clockwise to unscrew the blue insert from the main body.

Notice the black mark you made earlier in step 5.6. If all is well, this mark is directly opposite the factory-drilled hole within the blue inhale insert.

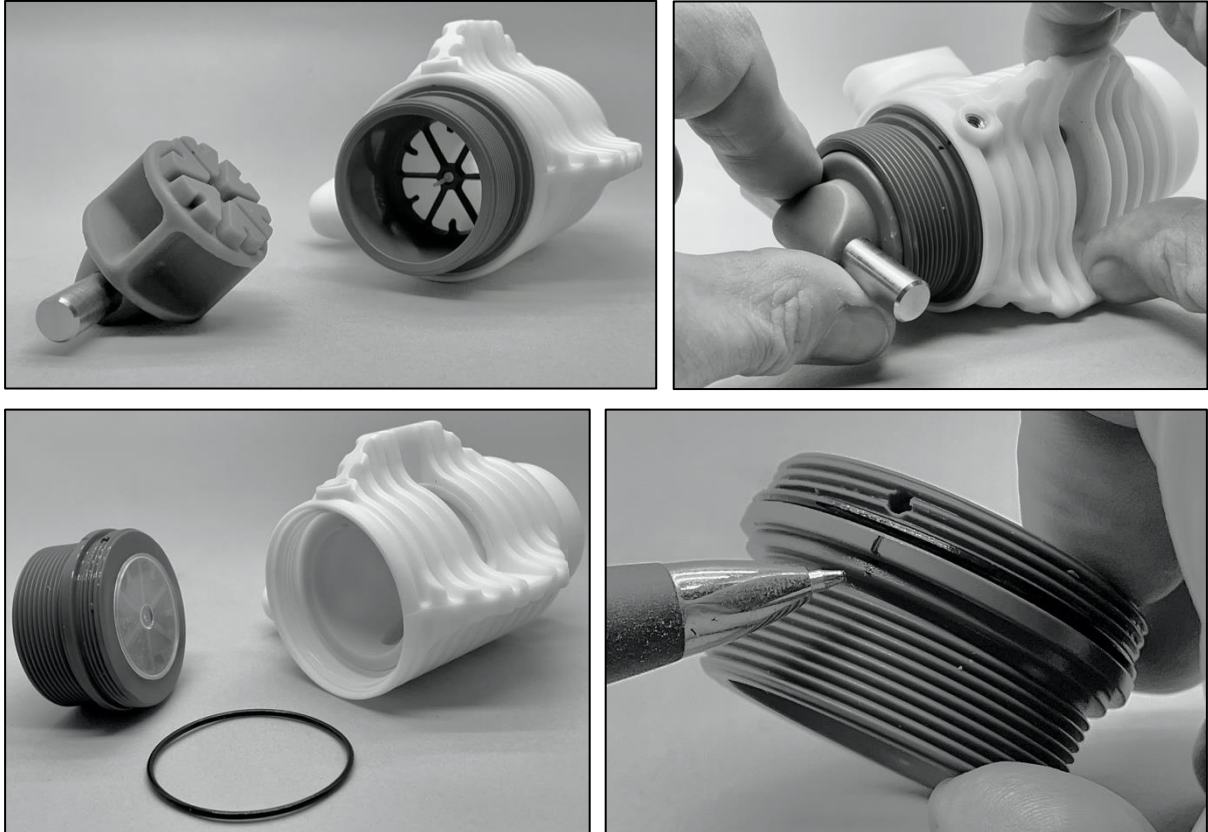

## 5.9 Remove the mouthpiece inner from the main body of the mouthpiece

With the mouthpiece orifice inline with the AP logo, use your thumb to carefully remove the mouthpiece inner from the main body. You might need to make a small rotating movement to remove the mouthpiece inner.

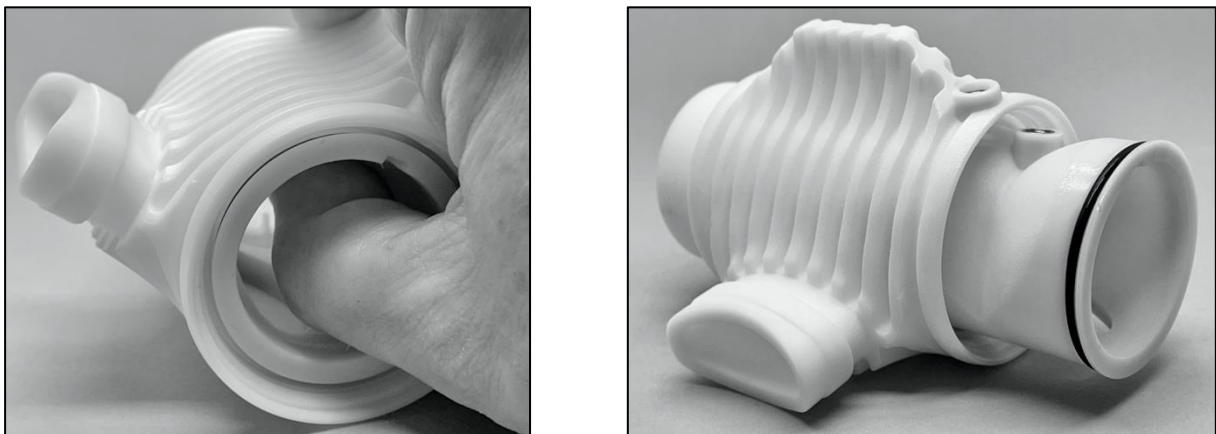

Once you have the mouthpiece inner removed, remove its 3 O-rings, ensuring you do not scratch the O ring sealing faces.  
Discard the O rings.

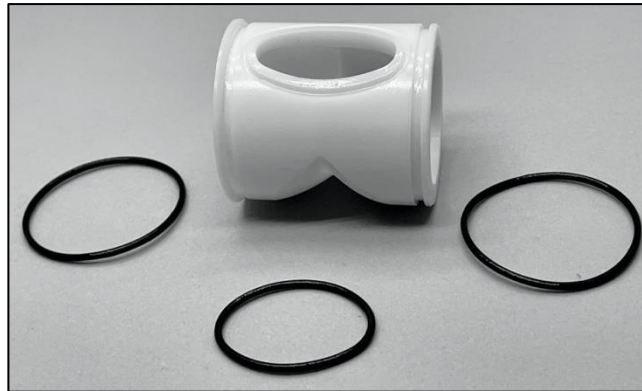
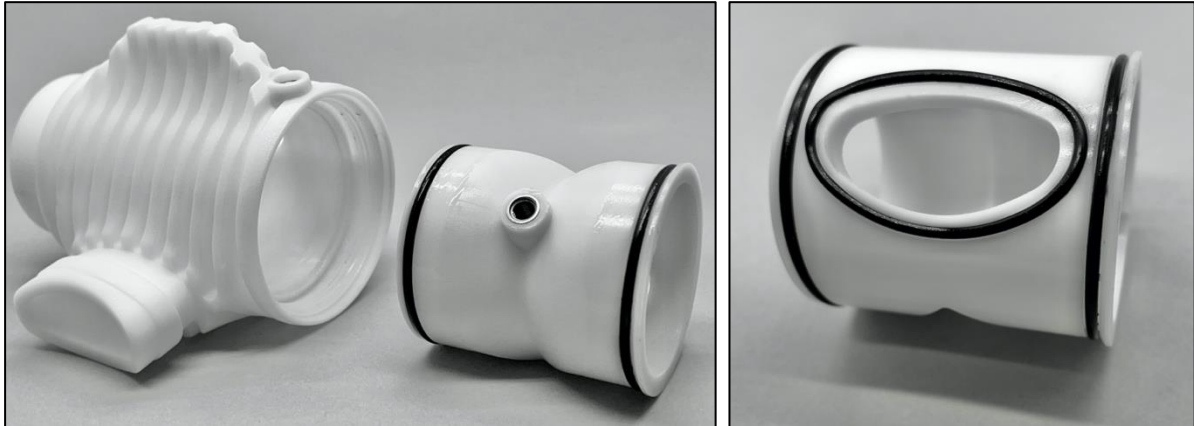

### 5.10 Optionally remove the one-way valves

Carefully inspect the one-way valves and clean in fresh water as necessary. If they show any sign of damage or wear, they need to be replaced. In that case, pull them from their position and make sure that no parts of the stem are left behind.  
Discard them and replace them with new ones.

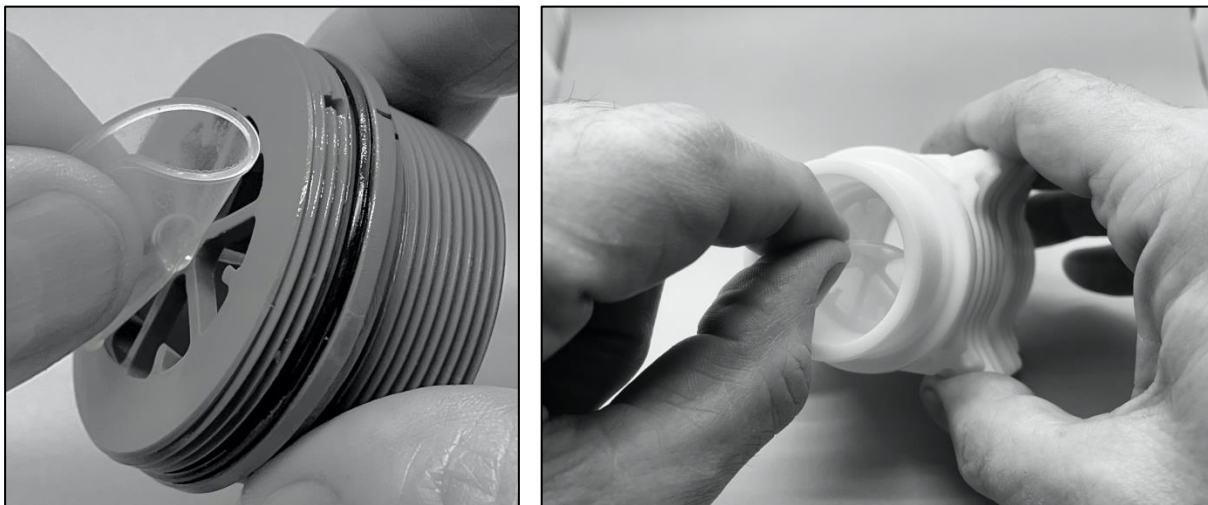



**5.11 Inspect all disassembled elements carefully for wear and tear**

Carefully inspect all parts. If any sign of damage or wear is spotted, replace the associated element with a new one, using the part numbers as shown in paragraph 3.1.

**This completes the disassembly of the RB160 Standard Mouthpiece.**

## 6. Clean and Replace Service Parts

The servicing of the RB160 Standard Mouthpiece contains 4 “action groups”:

1. Removing and discarding all parts that should be replaced. This includes all O-rings.
2. Inspect all parts for wear and tear. If necessary, replace damaged parts.
3. Ultrasonic-cleaning of all disassembled parts. This is recommended in all servicing situations.
4. Lightly grease new parts, fit them, and re-assemble the RB160 Standard Mouthpiece with the correct tools and the correct torques. Use appropriate silicon grease (e.g. AP70).  
Use the smallest amount of grease possible.

As described in chapter 4.1, service kit RB160KIT is available which contains the parts that need to be replaced when servicing the RB160:

| <b>RB160KIT</b> | <b>DESCRIPTION</b>                        | <b>QUANTITY</b> |
|-----------------|---|-----------------|
| 1               | BS006 N70 locking pin O-ring              | 1               |
| 2               | BS024 EPDM70 mouth opening O-ring         | 1               |
| 3               | BS029 EPDM70 mouthpiece inner O-rings     | 2               |
| 4               | BS032 N70 mouthpiece inhale insert O-ring | 1               |
| 5               | RB_02_05 One-way valves                   | 1 pair          |

### 6.1 Ultrasonically clean deposits from all metal parts

Clean deposits from all parts, like sand, chalk and salt.



**WARNING:** Do **NOT** use aggressive chemicals. They might damage the metal plating or plastic parts.

Use an ultrasonic cleaning bath with a suitable cleaning fluid instead. A good cleaning fluid is Biox “O2” immersion fluid, but the exposure time to this fluid must be **LIMITED** to 10 minutes. See WWW.BIOXINT.COM for further information and distributors.

### 6.2 Replace all O-rings with new ones from the Service Kit



**WARNING:**

- Replace **ALL** O-rings: do **NOT** re-use old ones.
- **ONLY** use original parts from APD, to make sure the O-rings are:
  - o the exact size
  - o the correct material (especially important in a high oxygen content and overpressure environment) and are
  - o the correct hardness (degrees Shore). For the RB160 all O-rings are 70 degrees Shore.

### 6.3 How to lightly grease O-rings

Note: the BS024 O-ring should not be greased until after it has been assembled into the Inner moulding, RB\_160\_2.

When greasing O-rings, use silicone grease and make sure **NOT** to use too much.

O2 compatible grease is not recommended for this application as it has the potential to become stiffer over time and clot.

The best way to grease O-rings is by using a simple “grease bag”.

A grease bag is a clean and clear plastic bag, into which you put a small amount of grease. Optionally you can make two bags: one with O<sub>2</sub> compatible grease, and one with normal silicone grease. Make sure you label them properly to avoid mixing them up! Also put a date on it, so you know how old your grease bag is. Don't use them longer than a year.

A nice advantage of using a grease bag is that you use only a tiny amount of grease for greasing many O-rings, so there is little waste.

We recommend that you use resealable bags, e.g. the ones with a plastic zipper, typically used for airtight food storage. This allows you to zip up the bag after use, keeping the contents clean for repeated use.

The simple steps are as follows:

- Take a plastic bag and deposit a **SMALL** amount of silicone grease in it.

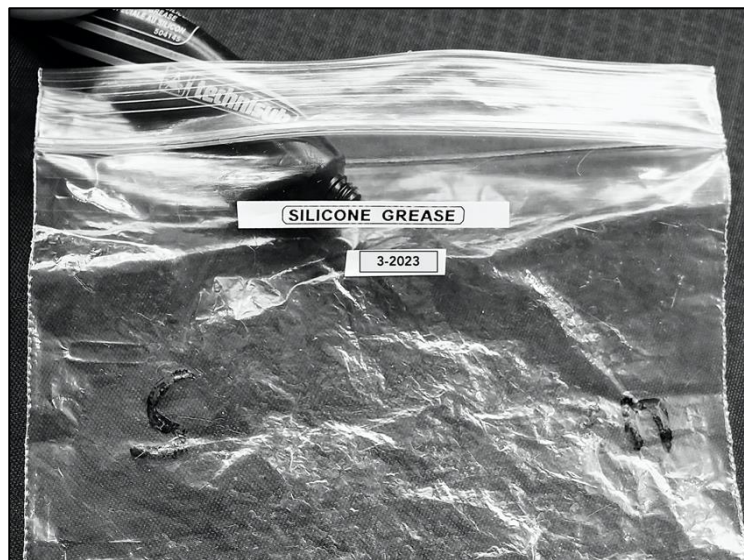

- Massage this grease all around the bag until it is evenly distributed over the inside surface area.
- Take the O-rings to be greased out of their storage container, either using gloves or using an instrument like a dental pick/hook.
- Drop them in the grease bag, and from the outside of the bag move them around with your fingers, making sure they get in full contact with the grease.

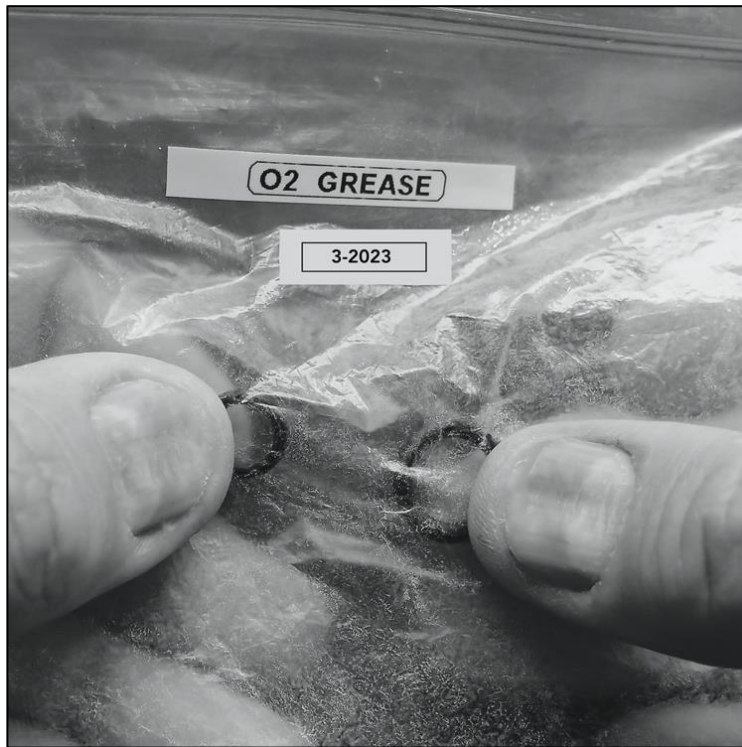

- Open the bag and, using a clean instrument like a dental hook, take the now properly greased O-rings out.



- Inspect them to make absolutely sure that the grease is evenly and lightly distributed on the O-rings and that there are no areas of excess grease - no globs or strands.
- Fit them where they belong on your diving equipment, still making sure not to touch them with your bare hands.
- **NOTE:** Do not grease BS024 EPDM O-ring as this needs to be dry for assembly.

## 7. Assembly Instructions

### 7.1 General overview: main assembly steps

There are 8 steps in the assembly process:

1. Grease and replace all O-rings
2. Optionally fit new one-way valves to main body and blue inhale insert
3. Refit the mouthpiece inner to the main body, using a special technique
4. Refit the blue inhale insert into the main body of the mouthpiece
5. Refit the nickel-plated-brass operating lever
6. Refit the locking pin into the main body of the mouthpiece
7. Optionally refit a new mouthpiece bite onto the main body and fit a new cable tie, using a cable tie tension gun
8. Screw the convoluted breathing hoses back onto the mouthpiece.

### 7.2 Replace and grease all O-rings



**WARNING:** Replace **ALL** O-rings: do **NOT** re-use old ones.

- ONLY use original parts from APD, to ensure the O-rings are:
  - o the exact size;
  - o the correct material (especially important in an overpressure environment);
  - o the correct hardness (degrees Shore).
- Make sure you use **ONLY** silicone grease.
- Pre-grease all O-rings **with the exception of the BS024 orifice O-ring:**
  - o that particular O-ring must be inserted **DRY** into the dry and clean orifice groove and then greased **ONLY** on the top side of the O-ring, once fitted.

### 7.3 Optionally fit new one-way valves to main body and blue inhale insert

Do **NOT** apply grease to the one-way valves.

Push the stem of the new valve through the centre of the spider-plate and pull them thoroughly through from the inside of either the main body or the blue inhale insert.

- When re-inserting the new one-way valves ensure the stems are pulled **FULLY** through the centre hole. The end will stretch and you will hear a “pop” as the one-way valve seats properly.
- When inserted, the centre of the downstream side of the valve must be completely flat. If they are not pulled through sufficiently far enough you will feel a raised bump at the centre of the downstream side and there is a real risk of Hypercapnia due to the valve not seating correctly.

Be sure to run your finger across the centre of the downstream sides of both valves to ensure that the one-way is seated sufficiently and not held up off the seat.

If necessary, use needle nose pliers to pull them secure. Place them as shown below.

Check proper placement after fitting by **GENTLY** rotating the valves, and **GENTLY** pulling on them. Make sure they do not come loose.

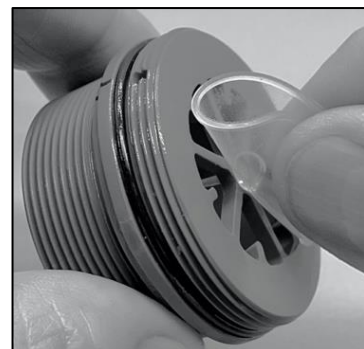



## 7.4 Refit the mouthpiece inner to the main body of the mouthpiece

**⚠ WARNING:** there is **A SPECIAL TECHNIQUE** for this. If you do not follow these instructions you **WILL** stretch the mouthpiece orifice O ring which will result in the mouthpiece jamming catastrophically between open/close, rendering the valve unusable.

Fit the two BS029 new O-rings after properly greasing them with silicone grease:

- Push the O-ring **GENTLY** and **EVENLY** into the groove and then wipe over the O-ring with your finger.
- Then apply a very small amount of grease to the **BORE** of the outer moulding, paying particular attention to the area on the underside of the AP logo.

Remember to **NOT** grease ***the BS024 orifice O ring*** upfront:

- The slot it sits in and the O-ring itself must be clean and dry.
- This O-ring must be inserted **DRY** into the orifice groove and then greased **ONLY** on the top side of the O-ring, once fitted, afterwards.

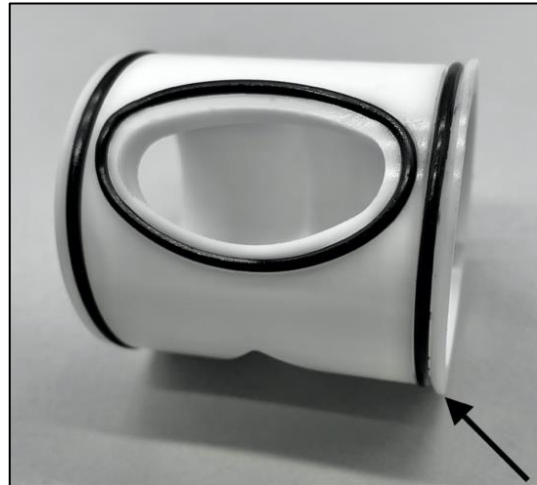
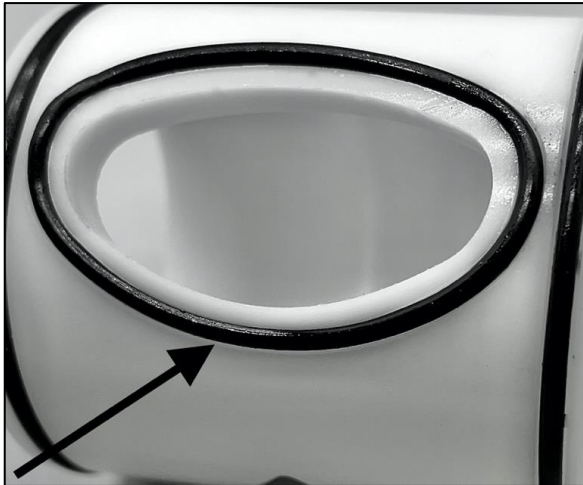

Notice that the mouthpiece inner is **NOT** symmetrical: one side has a higher rim than the other side, as indicated by the arrow in the picture above right. The inner can only be fitted one way. Do **NOT** force!

With the mouthpiece opening facing the AP logo, as shown below,

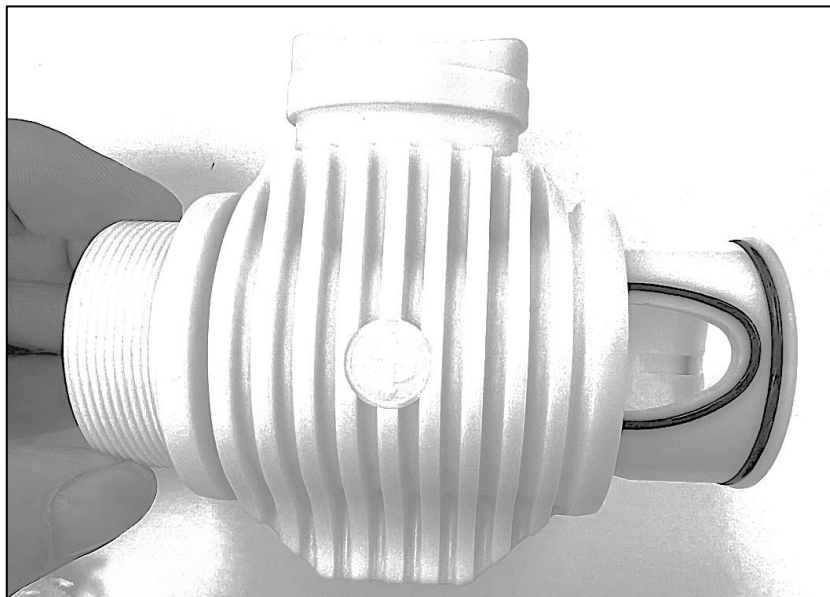

**CAREFULLY** re-insert the inner into the outer, with a **VERY SLIGHT** twist as you push past the first O ring:

- Take care **NOT TO SCRATCH** the bore or dislodge any of the O rings.
- Do **NOT** try to push the inner in, in one go; push the inner in a small way, then withdraw slightly, then push in again with a slight twist, slightly further each time.

The O-ring will be visible up until the last insertion. At this point you **MUST** stop and look at the O ring and, using **DOWNWARD** pressure to reduce the pressure on the mouthpiece orifice

O-ring. Now, with **VERY SMALL** sideways and in-and-out movements, get the last part of the O-ring in without stretching or trapping it:

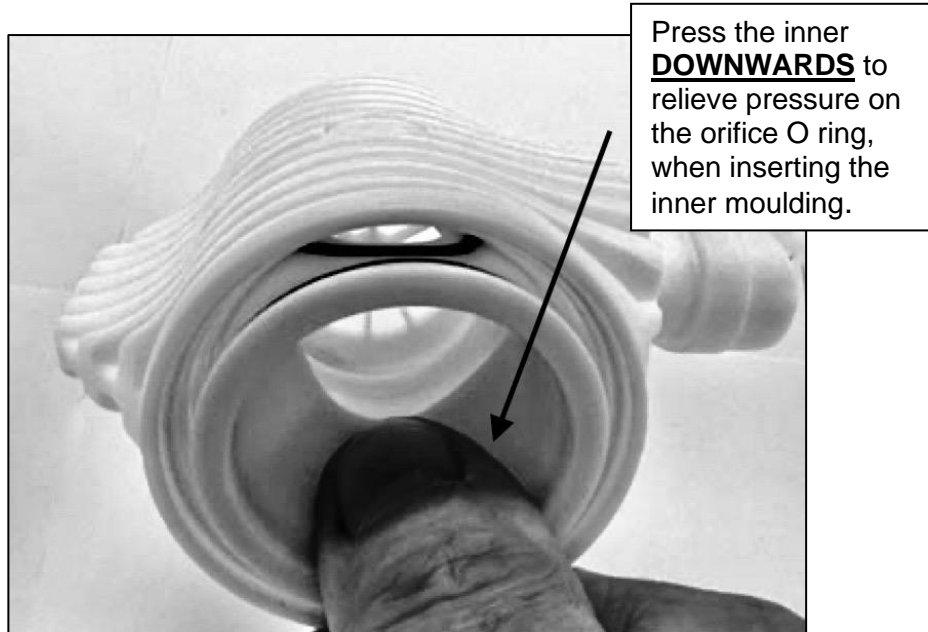

Once the mouthpiece orifice O ring is fully in, the inner part needs to be pushed fully home so the inner is past the interior lip. You should hear an audible “clunk”:

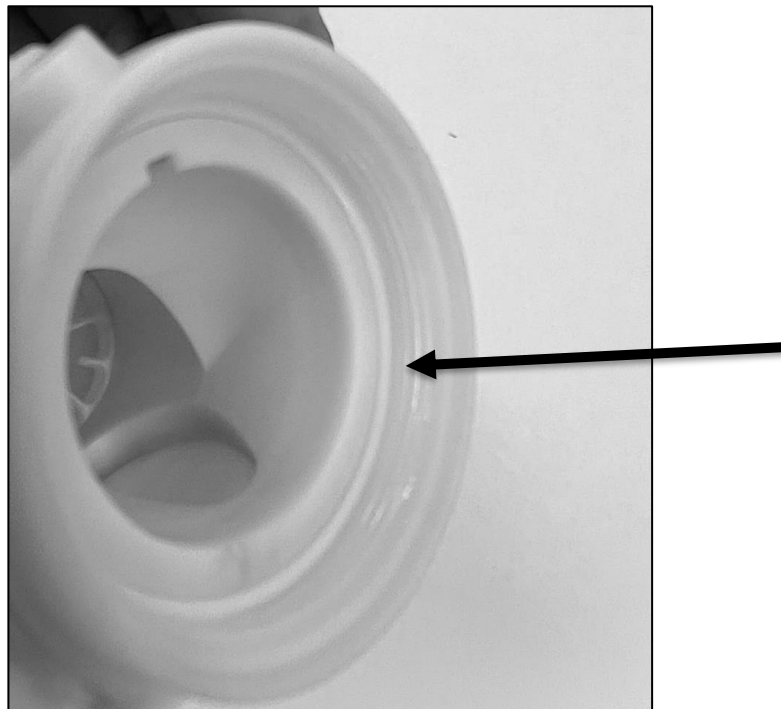

Once it is fully in, the operating lever can be screwed in and the mouthpiece should be slowly and carefully opened and closed to **check** whether the mouthpiece orifice O ring will get caught or not on the lip:

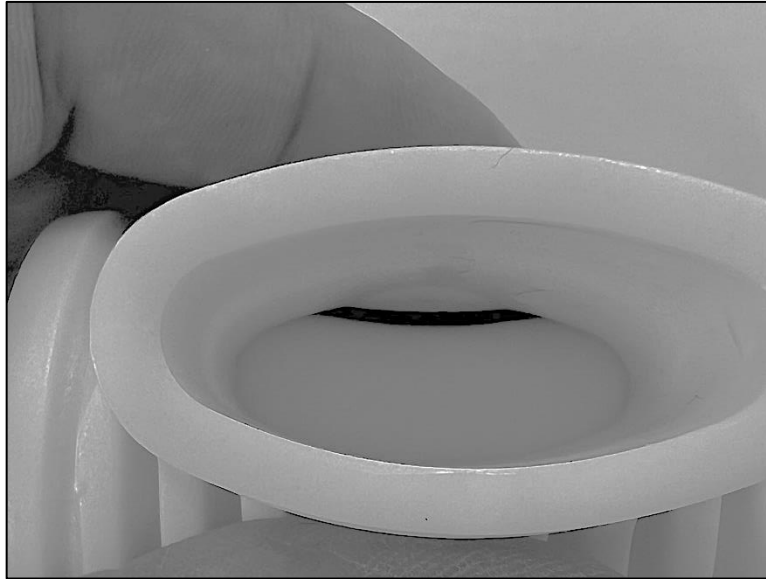



## 7.5 Refit the blue inhale insert into the main body of the mouthpiece

Fit a new greased O-ring onto the blue inhale insert.

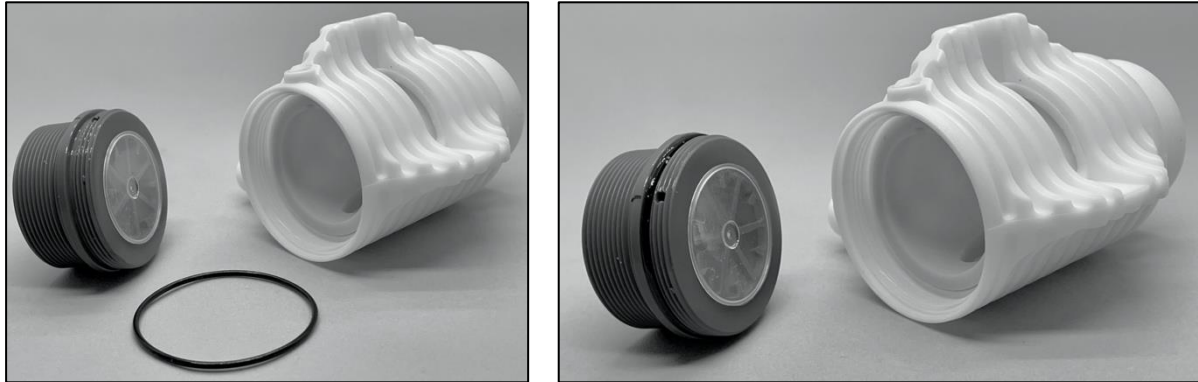

Using special tool RBTOOL22, screw the blue insert back clockwise into the main body, until the previously made black mark is lined up exactly opposite the screw hole of the locking screw.

Looking through the screw hole, you should now see the factory-drilled hole lined up. If it isn't lined up, screw the blue fitting in or out slightly until the hole in the outer is exactly in line with the factory pre-drilled hole.

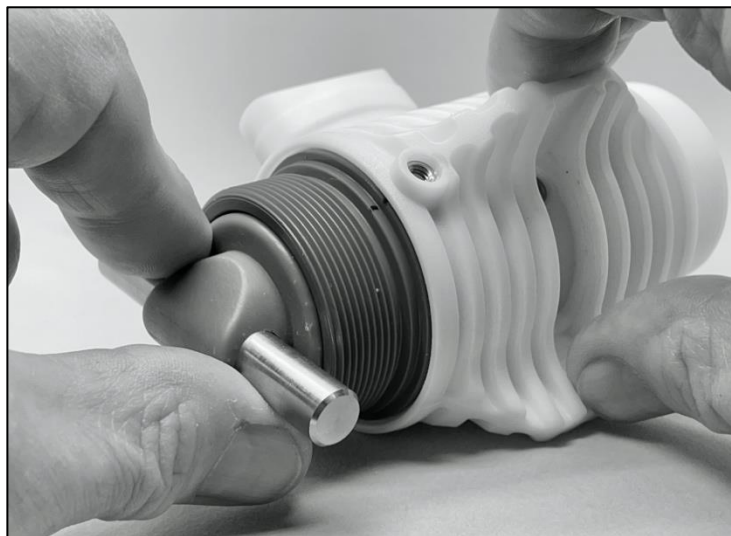
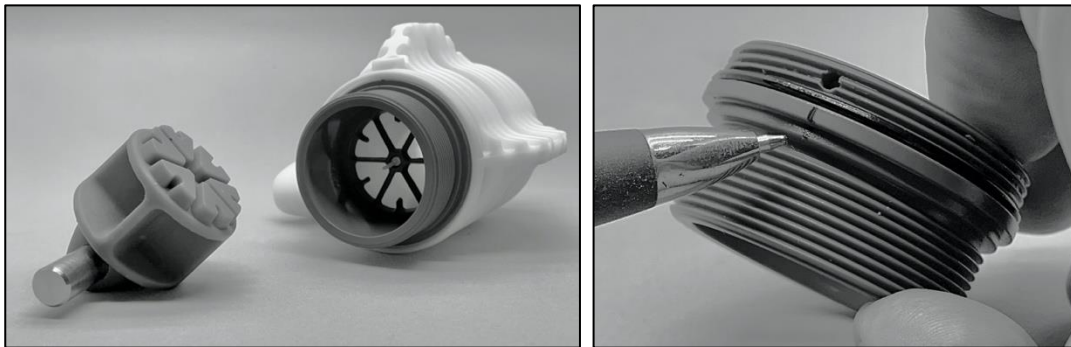

## 7.6 Refit the nickel-plated-brass operating lever

Using a torque wrench with low settings, use a 4mm Allen size to screw the nickel-plated-brass operating lever back into the mouthpiece inner. Use a torque of 2Nm.



## 7.7 Refit the locking pin into the main body of the mouthpiece

Grease and fit a new O-ring onto the locking pin. Screw it back into the main body, using a torque of 2Nm.

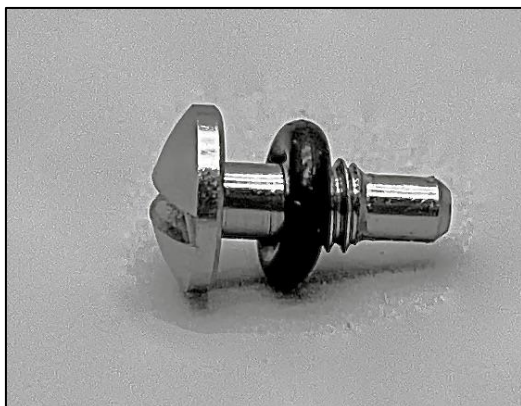
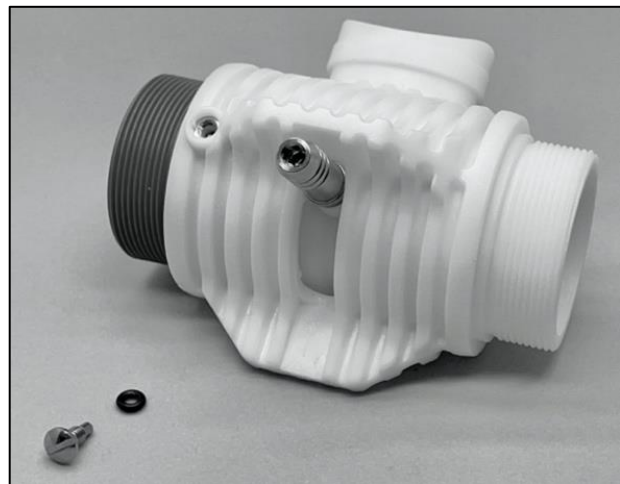

## 7.8 Optionally refit the mouthpiece bite onto the main body

The OEM AP Diving mouthpiece bites have a recess on the inside that slips onto the raised rim on the main housing, as shown on the pictures below:

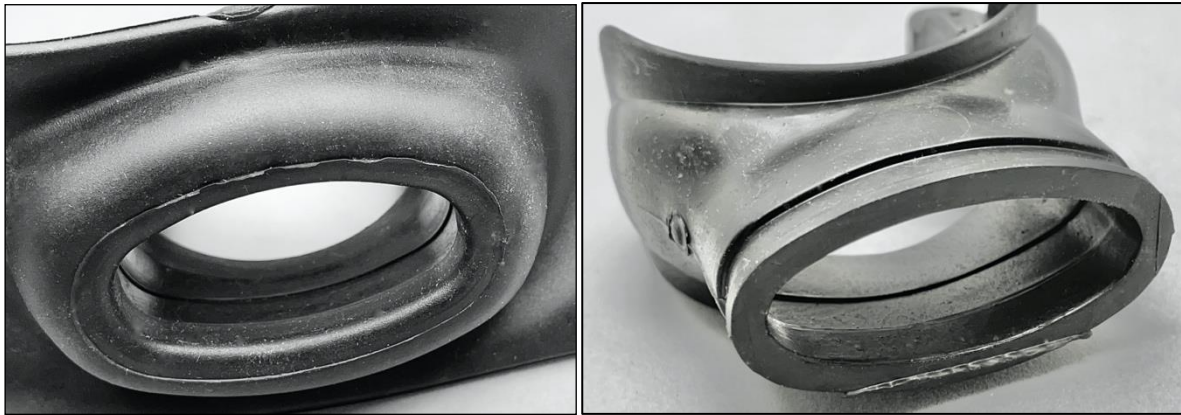

The picture below shows correct positioning of the mouthpiece bite on the main housing. Notice that there is **NO VISIBLE GAP** between the end of the mouthpiece bite and the main housing.



The pictures below show **INCORRECT** positions of the mouthpiece bite on the main housing. Note the visible gap between the end of the mouthpiece bite and the main housing. In the second example, the mouthpiece bite is also not properly aligned horizontally.

- Both incorrect positions result in the recess inside the mouthpiece bite not hooking onto the raised rim of the main housing, reducing the attachment security.



INCORRECT: visible gap



INCORRECT: no horizontal alignment

## 7.9 Fit new cable tie, using cable tie tension gun

Whenever a new mouthpiece is fitted use a new single use cable tie to reattach the mouthpiece.

APD **STRONGLY** recommends the use of the original cable ties (AP21) that are provided with their mouthpiece bites. Mouthpiece bite and cable tie are purchased together as a set.

- Paragraph 6.11.5 of the European EN14143:2013 NORM for rebreathers prescribes that a mouthpiece should be able to withstand a minimal pull of 80 Newtons. With the AP Diving cable tie and correct tensioning using the correct tool it is possible to exceed a 200 Newton pull.

APD **STRONGLY** recommends the use of a proper cable tie tension gun to tighten up the cable tie. Not using a proper tension gun and/or original cable tie could lead to a too low tension on the cable tie, potentially leading to the mouthpiece bite coming adrift from the RB160 during the dive with potentially catastrophic results for the diver.

- See paragraph 3.2 for a suggestion of proper cable tie tension guns that deliver sufficient tension.

For comfort, it is important that the grip block of the cable tie (its “lock”) is located to the **SIDE** of the mouthpiece bite, **NOT** on the top or bottom. Double-check these points before tensioning the cable tie.

Tension the cable tie as much as possible, using a suitable cable tie tension gun.

- Follow the setting instructions that come with the tension gun to make sure it applies a tension of at least 80 Newtons.
- For the Anvil tension gun used in the picture (see paragraph 3.2 for a link to its distributor) this means setting the gun to its highest position of 3.

Test the mouthpiece bite by pulling it after fitting. If it appears as though it might come off, remove the cable tie and fit a new cable tie, ensuring it is tightened more.



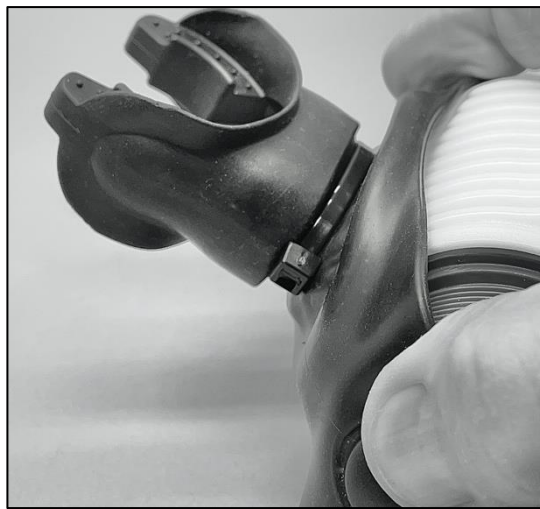
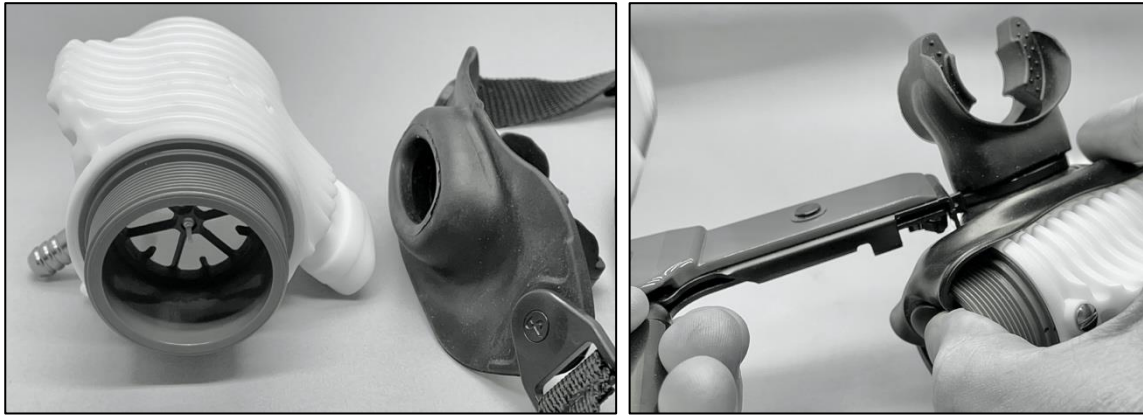

The picture below shows fitting the non-safety mouthpiece bite in a similar way:

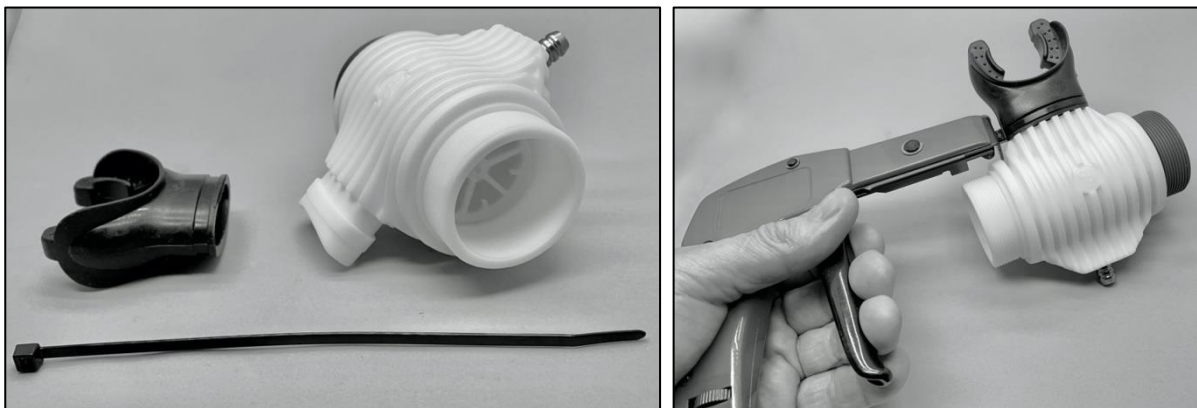

## 7.10 Screw the convoluted breathing hoses back onto the mouthpiece

Inspect the O-rings inside the hose ends, ensuring they are seated in their grooves. If needed, grease and/or replace them.

Screw the convoluted hoses back onto the mouthpiece:

- The inhale hose, fitted with the blue marker rings, goes onto the side of the mouthpiece with the blue insert.

Screw the hoses on hand-tight until they lock up.

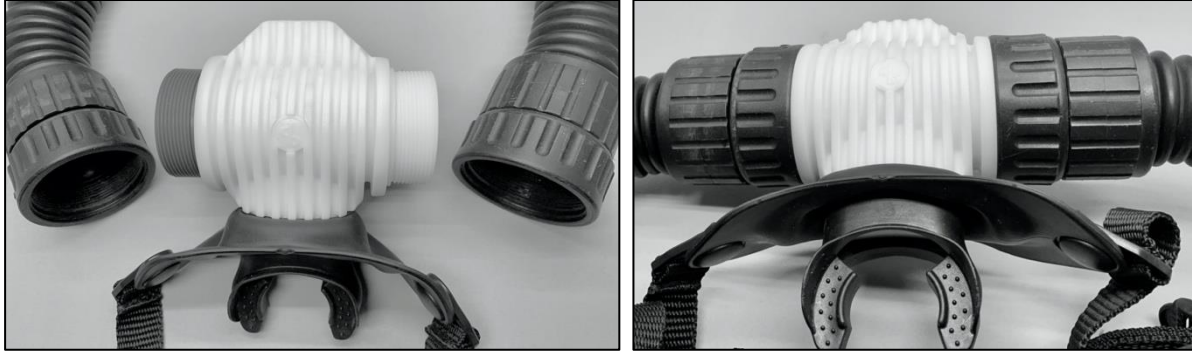

Do **NOT** refit the stainless steel pozidrive screws back. They were needed with the older APD mouthpieces, but are not needed anymore with this RB160 Standard Mouthpiece.

**This completes the re-assembly of the RB160 Standard Mouthpiece.**

## 8. Testing Instructions

### 8.1 Test for leaks and proper operation

- It is essential to perform a complete test and inspection of your mouthpiece after assembly. This inspection is similar to the pre-dive inspection as described in the RB160 User Manual.
  - o **NEVER** dive with any diving equipment that shows signs of damage, debris, loose connections or unsatisfactory performance.
- Carefully inspect all hose fittings to ensure they are securely connected at both ends.
- Inspect along the length of each hose to ensure that the hoses are not blistered, cut, or otherwise damaged.
- Visually inspect the mouthpiece bite for damage or cuts and ensure it is securely fastened to the Mouthpiece.
- Check the rebreathers non-return valves for back leaks:
  - o Located within each end of the mouthpiece are the non-return valves which are fitted to ensure they pass gas the correct way around the rebreather.
  - o **It is essential to check the direction of gas flow and check the proper operation of the non-return valves.**
  - o The valves can leak due to debris left over from cleaning, due to faulty assembly, worn components or due to being frozen open (in freezing conditions).
  - o This check can be easily carried out by disconnecting the hose connectors from their respective T-pieces and gently blowing and sucking against the connectors.
- The direction of gas flow for the Ambient Pressure Diving rebreathers is clockwise when looking down on the unit. i.e. you inhale from over your left shoulder and exhale over your right shoulder. The correct flow direction is from left to right when looking at the mouthpiece with the logo on top.
- Therefore, when blowing into the right-hand side **exhale hose** connector (this is the hose **WITHOUT** the blue ident rings) the non-return valve will close, and then open when air is sucked from the connector.
- The non-return valve at the other end of the mouthpiece (the inhale side) should close when air is sucked from the connector on the left-hand **inhale hose** (this is the hose **WITH** the blue ident rings fitted) and open when air is blown into the connector.
- After reassembling the hose to the unit, check for correct operation by alternately squeezing the inhale and exhale tubes as you inhale and exhale:
  - o Gas must come from the left and go out to the right.
  - o You must not be able to inhale gas from the exhale tube and exhale gas into the inhale tube.
- Check for a smooth and positive switching operation using the lever, switching between OPEN and CLOSED modes, ensuring the mouthpiece orifice O ring does not become trapped.
- In the closed-circuit position, carry out a positive and negative pressure test of the breathing loop.

If all tests are passed OK - your maintenance has been successful.

**NOTE:** If you are storing your mouthpiece, APD advise you store it in the closed position.